







WOODEN DOG HOUSE ASSEMBLY INSTRUCTIONS

- (A)  Bolts and nuts: 3pcs (M6x60)
- (B)  Bolts and nuts: 12pcs (M8x50)
- (C)  Bolts and nuts: 12pcs (M8x60)
- (D)  Screws: 8pcs (M3.5x35)
- (E)  Screws: 8pcs (M3.5x30)
- (F)  Screws: 6pcs (M3.5x50)
- (G)  Nuts: 3pcs



Step 1: Install floor.

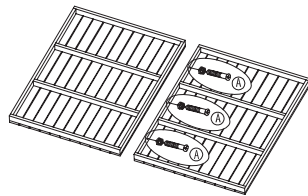
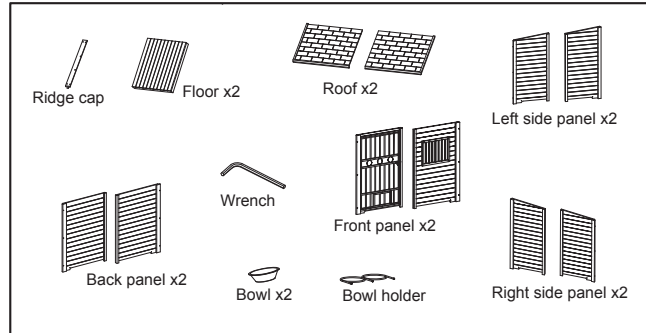
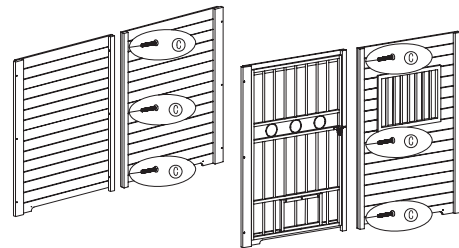

Step 2: Install front and back panels.

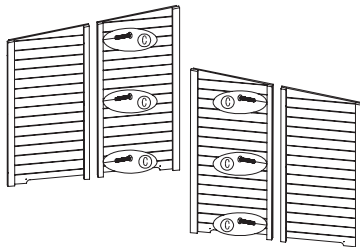

Step 3: Install left and right side panels.

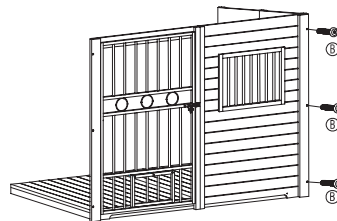

Step 4: Insert floor and secure front and right side panels.

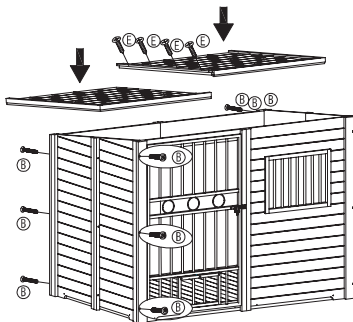

Step 5: Secure left side and back panels.
Attach roof and secure right side of ridge cap.

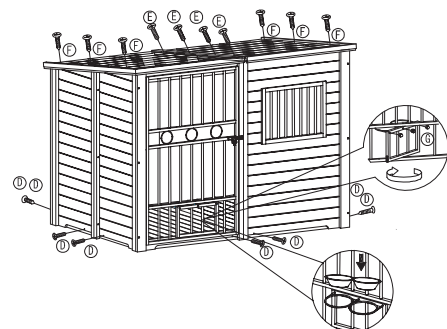

Step 6: Secure left side of ridge cap.
Secure bowl holder and placed bowl.